



1400cc (1300cc) Stock Cars 2026



2026 Rules & Regulations 1400cc / 1300cc STOCK CARS

Contents

1. THE FORMULA	3
2. ELIGIBLE CARS	3
3. VIOLATIONS	3
4. PERSONAL SAFETY	4
5. SAFETY EQUIPMENT	4
5.1 CRASH HELMET	4
5.2 RACING OVERALLS	4
5.3 GLOVES	4
5.4 BALACLAVAS	4
5.5 A NECK BRACE	4
5.6 WET WEATHER CLOTHING	4
5.7 WINDOW NET	4
5.8 1kg FIRE EXTINGUISHER	4
5.9 COMPETITION STYLE DRIVERS SEAT WITH HEAD RESTRAINT	5
5.10 SAFETY HARNESS	5
6. ROLL CAGE	6
7. UNDER IRONS (Optional)	9
8. FRONT & REAR BUMPERS	10
9. SIDE IRONS	11
10. FRONT WHEEL PROTECTION	13
11. REAR WHEEL PROTECTION	13
12. WHEELBASE	14
13. VEHICLE WEIGHT	14
14. FRONT SUSPENSION	14
15. REAR SUSPENSION	15
16. THE STEERING	15
17. THE SPRINGS	15
18. RIDE HEIGHT	15
19. FRONT SHOCK ABSORBERS	15
20. REAR SHOCK ABSORBERS	16
21. WHEELS & TYRES	16
22. FINAL DRIVE	16
23. GEARBOX & PROPELLER SHAFT	16
24. BRAKES	17
25. ENGINE	17
26. ENGINE SEALING	18
27. OIL CATCH TANK	18
28. COOLING SYSTEM	18
29. IGNITION SYSTEM – DISTRIBUTOR	18
30. CARBURETTOR & INLET MANFOLD	18
31. FUEL SYSTEM	19
32. EXHAUST SYSTEM	20
33. BATTERIES & THE ELECTRICAL SYSTEM	21
34. TRANSPONDER	21
35. MIRRORS	21
36. BODYWORK	21
37. PAINTWORK	26
38. SUN VISOR	26
39. FIN PLATES	26
40. DOOR NUMBERS	26
41. ROOF GRADING	26
42. SPECIFICATION & RULE CHANGES	26
43. SCRUTINEERING OF NEW CARS	27
44. RACE REPAIRS AT TRACK	27
Spedeworth / Trackstar Evolutionary Stock Car Specification as 2015	27

1. THE FORMULA

The object of the race is to complete the specified number of laps in the shortest time. This is a full contact formula. No hitting parked cars, no four wheels cutting the corner, and no deliberate driver's door contact. You may push a car from behind or spin a car left or right. Attacking a car from or on the safety infield is also not permitted. Additional to the above you cannot follow a car in on the drivers side of the car or hit a car that hard you end up hitting it in the side as it hits the fence, if such action is considered by the meeting steward to not be in within the spirit of the rules/racing to win the offending driver will be subject to a immediate suspension pending a review, to determine whether or not it was done in malice or not. Fencing of a car can only be done by front bumper on the back bumper (As expected in full contact racing). To clarify for racing on shale sliding up the inside of another car is accepted in the spirit of the rules, is often unavoidable and is considered part of racing to win.

Actions deemed to be deliberate or dangerous will carry penalties.

Racing is in a clockwise direction on a clearly defined circuit with a separate infield.

You may not use the outside wall to gain an advantage during a race (I.E No deliberately riding the outside wall), this will carry a Black cross or Black flag

The Malcom Girling Rule may only be used on championship races which covert a roof grade e.g. World Championship. This is when a car has deliberately been taken out by breaking the rules of racing within the last 3 laps of the race e.g. a car coming off the infield to stop the leader / a car giving a 'head-on'.

This does not include a lapped car taking out the leader providing the manoeuvre used is within the permitted rules of racing. If the Steward Of The Meeting decides that the Malcolm Girling has come into effect the result shall go back to when the offence occurred and the leader of the race at that point will become the winner. The Malcolm Girling rule only applies to the driver leading the race.

2. ELIGIBLE CARS

Any 1300cc Carburettor fuelled, metal bodied, four -seater saloon or hatchback as listed below. Drivers wishing to race alternative vehicles must contact the Promoter.

Vehicle Make & Model	Engine Capacity	Carburettor Venturi Diameter
Citroen AX 11	1124cc	25mm
Colt Lancer	1288cc	21/27 mm
Colt	1200cc	21/27mm
Datsun Sunny 1300	1296cc	20/26 mm
Fiat Uno	1299cc	19/23mm Weber 30/32mm
Ford Ka	1300cc OHV or CVH	23/24mm ohv 24/25mm cvh
Ford Fiesta Mk 2-5	1300cc OHV or CVH	23/24mm ohv 24/25mm cvh
Ford Escort Mk 1-3	1300cc OHV	23/24mm
Ford Escort Mk 3	1300cc CVH	24/25mm
Mazda 323	1300cc	21/27mm
Peugeot 205	1294cc (OHV engine only)	36 DCN VH17 Weber or 26 Weber 321 BSH
Toyota Corolla 1300 DX	Must use the standard 1200cc carburettor	21/24mm
Toyota Corolla SR Coupe		18/24mm
Toyota Starlet 1.3	1290cc (Must use 1200cc carb)	21/24mm
Vauxhall Nova, Corsa, Tigra		Peirburg 2E3 20/24mm
Volkswagen Golf, Polo, Passat		21/23 or Peirburg 2E3 20/24mm

3. VIOLATIONS

1. **When referring to the engine, gearbox, final drive, mechanical or construction Rules & Regulations, the principle will always be: Unless permission is specifically granted to make modifications (or any variation) nothing may be done to alter or change the Standard Parts in any way.**
2. It is the responsibility of the Driver to prove to the Promotion that the part is legal, by way of written proof of where the part originated. This must be undertaken within 7 days, otherwise the item in question will be deemed illegal, resulting in immediate suspension from racing & referral for disciplinary action. **Unless the rules say you can do it, you cannot do it!**
3. Presentation of a Vehicle for Scrutineering is a declaration by the entrant that the vehicle is eligible for that event.
4. Car engines & fuel will be checked on a random basis. Violations or refusal to allow an engine check will result in an immediate suspension of all racing facilities.

5. All Car and Engine Specifications will be taken from either the manufacturers Technical Specifications or the Technical Service Data books as published by Glass's Guide.
6. Should a discrepancy occur between the Specifications then the Promotion will exercise its judgement, and that decision will be final.
7. Clarification on any one item may be sought from the Promoter.
8. Each driver is permitted one car per meeting & each car is permitted one driver per meeting.

4. PERSONAL SAFETY

Drivers are advised that under Health & Safety, they are responsible for their own and their Mechanic's actions. Promoters have had complaints made about Registered Drivers & Mechanics consuming large amounts of alcohol at meetings, which could effect their judgement or be detrimental to their health, when medical attention has to be administered by Paramedics, St Johns or Hospital Staff. Should an incident occur that proves fatal on the raceway and you are involved, it is likely that the Police will want interview you. **If you drive, don't drink!** Scrutineers and Officials will report to the Clerk of the Course, anybody they believe is under the influence of Drink or Drugs. Drivers whom it is thought are under the influence may be breathalysed. You have been warned!

It is also apparent that some drivers are not aware of the flags used by the track staff so here is a reminder:

- Waved Green Flag – Go, the race is on.
- Waved Red Flag – Stop racing slow down & stop.
- Chequered Flag – Race winner has crossed the line, continue to race until the Red Flag is shown.
- Held Yellow Flag – Beware, you are approaching a hazard on the track, continue to race.
- Waved Yellow – Slow down to 15mph, hold your position, and do not overtake any other cars.
- White Flag with a Blue spot – Oil on the track.
- Waved Black Flag - You are disqualified, pull off the track immediately.
- Black cross on a White board – You have committed an infringement and may be penalised in the results.
- White Flag with a Red Cross – Technical Disqualification, leave track immediately

Drivers are also reminded that they should line up on the grid with their engines switched off in the correct points order, unless told otherwise.

5. SAFETY EQUIPMENT

5.1 CRASH HELMET

Please visit the ORCi website www.orci.co.uk for current safety equipment regulations.

5.2 RACING OVERALLS

Please visit the ORCi website www.orci.co.uk for current safety equipment regulations.

5.3 GLOVES

Please visit the ORCi website www.orci.co.uk for current safety equipment regulations.

5.4 BALACLAVAS

Please visit the ORCi website www.orci.co.uk for current safety equipment regulations.

5.5 A NECK BRACE

Please visit the ORCi website www.orci.co.uk for current safety equipment regulations.

5.6 WET WEATHER CLOTHING

Please visit the ORCi website www.orci.co.uk for current safety equipment regulations.

5.7 WINDOW NET

You must have a cloth type Window Net with a maximum spacing of 76mm x 76mm, which must be fitted with a quick release mechanism.

5.8 1kg FIRE EXTINGUISHER

Please visit the ORCi website www.orci.co.uk for current safety equipment regulations.

5.9 COMPETITION STYLE DRIVERS SEAT WITH HEAD RESTRAINT

You must have a Competition type Driving Seat with a head restraint. The seat should occupy its original position where possible and be suitably supported at shoulder height and on both of the sides and back, with a suitable framework or seat stiffener's.

Additional wrap around seat support at shoulder height.

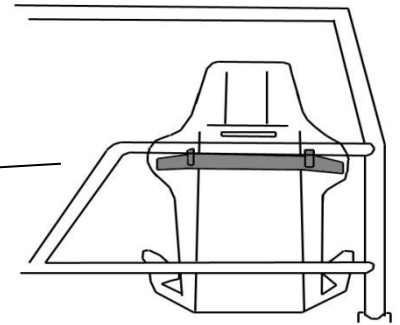

Extra padding recommended in the back of the seat

5.10 SAFETY HARNESS

The lap belt/straps and crotch straps should not pass over the sides of the seat, but through it, in order to wrap and hold the pelvic region over the greatest possible surface

It is mandatory to have a 5 point Safety harness with 3" shoulder straps, the lap & crotch straps can be either 2" or 3" in width.

All seatbelt connection points must be visible and no belts must pass through any firewall.

The Only exception to the 3" shoulder strap is if you are wearing a Forward facing head restraint .

Following research made by leading safety harness manufacturers, information has been made available with regard to the best way to fit your safety harness; this will further ensure your safety. Please study the diagrams to ensure your safety harness is fitted correctly.

The lap belt crossing should be below the anterior-superior iliac spines (bony part of the hip). Under no circumstances should it be worn over the region of the abdomen.

Lap belt/straps must terminate vertically downwards, and not forwards or rearwards of the hip joint. Lap straps should terminate symmetrically about the wearer on either side of the seat, about 20" (500mm) apart. The distance between the seating surface and the anchorage point should be kept to a minimum to prevent submarining. The location of the crotch strap mounting should be to the rear of the driver.

Only safety belts comprising of separate shoulder, lap, and sub-straps will be permitted.

The sub-strap must be used at all times, and all belts must connect to the quick release buckle. The abdominal strap fixing point must be on the chassis, roll cage, or floor (for vehicles with no chassis), either side of the driver.

The shoulder straps must be supported at shoulder height. NASCAR type buckles must be fitted with lever on the right side of the driver. It is advisable to fit a secondary means of detent to prevent overall sleeves accidentally unhooking the buckle during racing. A small section of tube grip elasticated bandage, slid over the hooked buckle, serves the purpose.

Special attention must be paid to the condition of seat belt fixings once fitted. Information is available, from your Promotion, on the correct procedure to follow when fitting seat belts. *Remember - your life depends on them, and belts, once involved in a severe accident, should be discarded and replaced.*

Over the years, we have had many unnecessary injuries due to badly fitted seats. They frequently occur in Non-contact Formulas, when perhaps a driver believes it is more unlikely that he will be involved in a serious crash, and he also believes that, if he is involved in a collision, the impact on his car will be from the front. However, this is often not the case. It is therefore, imperative that you ensure your seat is really well supported, especially where the shoulder straps go through. You must also ensure that your seat cannot move sideways.

The safety of your seat will be judged by the Scrutineer's and you will only be permitted to race when they are satisfied that you will be as safe as possible in any event.

RACEIVER:

All drivers MUST use an official Raceiver.

Any driver whose Raceiver is not working when forming the grid prior to a race will not be allowed to race, unless it can be repaired before the race start.

It is strongly recommended that you carry a spare battery either in your overall pocket or taped inside your car.

6. ROLL CAGE

Key: SHS - Square Hollow Section.
RHS – Rectangular Hollow Section
CHS – Circular Hollow Section

The roof may be removed to aid welding and fitting of the cage, this must be cut at the 'a' pillars and not across the bulk head. Any cars that have a removal roof that incorporates the bulkhead must have the bulkhead including in bottom of the 'a' pillars welded back in its original position by 1/4/23, This must be a minimum of 3 plates (Left, Centre and Right). These plates must be a minimum of 3mm thickness and 150mm wide and 50mm deep (see pic), it must not be lowered or shortened when refitted. The roll cage must be constructed from either 38mmx38mm or 40mmx40mm SHS or CHS, with a wall thickness of 3 to 3.5mm & it must support both the A & B pillars. The cage must consist of the following minimum iron work.



If cross 1 more down bar

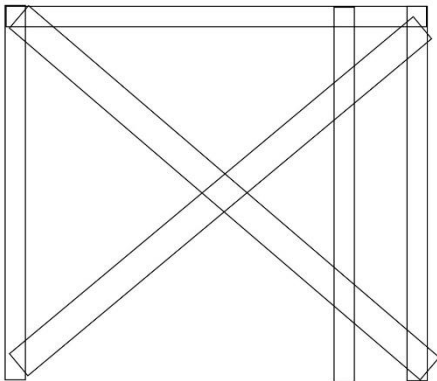

If no cross 2 more down bars

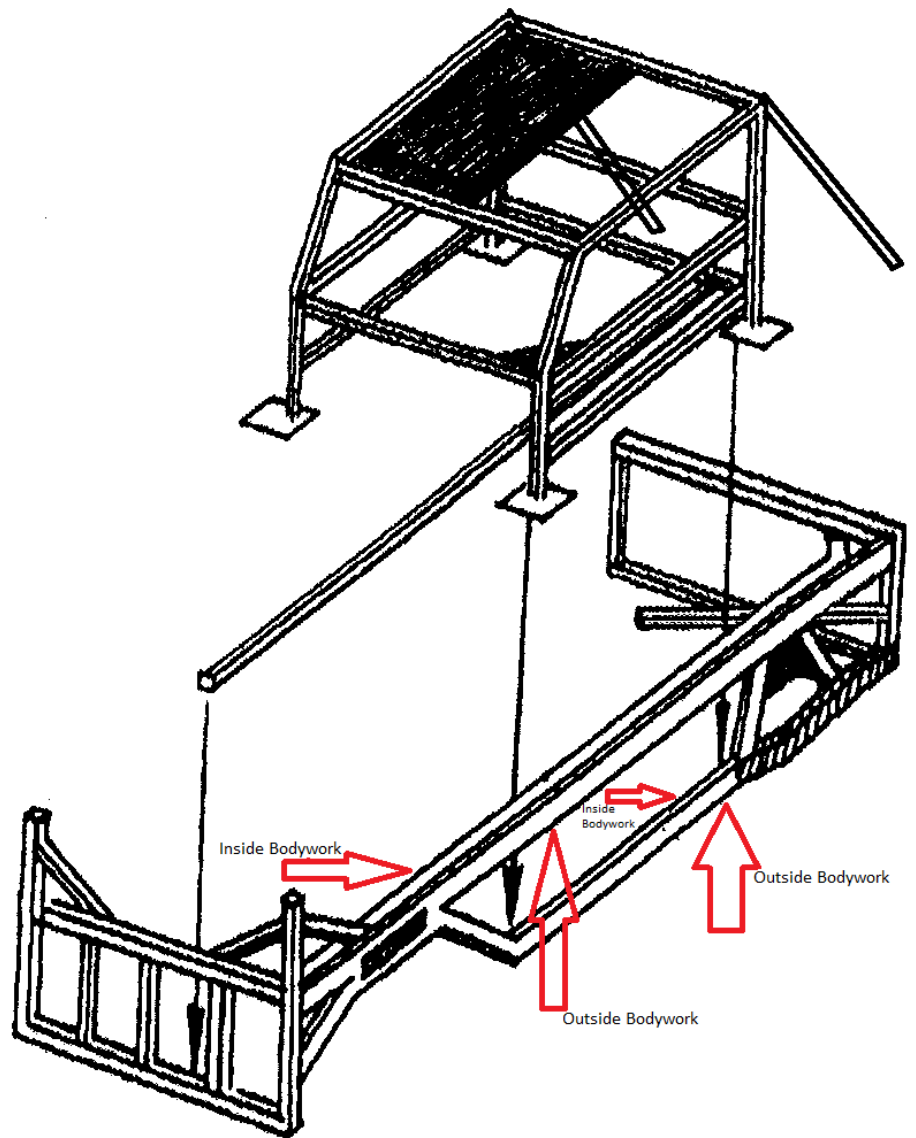
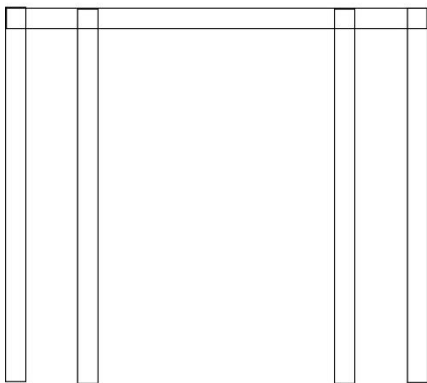

1. One front hoop over the A posts.
2. One rear hoop over the B posts.
3. Two connecting rail roof bars connecting the A&B hoops, with an additional third centre roof bar.
4. A 3mm plate is to be welded on all four sides on the driver side from centre bar to cover completely the driver side as shown in diagram
5. The roll cage hoop feet must be welded to four 3mm thick plates 100mm square or alternatively welded to the Steel Work
6. There must be one front crossbar at dash height.
7. There Must be a minimum of one cross bar behind the driver .
8. Both front doors must have two chicken bars linking the A&B posts.
9. Drivers doors must have a 3mm thick plate welded on the outside of the chicken bars, and may substitute the original outer body panels between the front & rear wheels. Alternatively if the original outer panels are used the 3mm plate needs only to be a minimum of $\frac{2}{3}$ of the width of the door, placed centrally between the A&B posts.
10. It is compulsory to weld a 3mm thick driver's floor plate from just below the pedals to the rear of the driving seat if no under-irons are fitted. (under irons may run underneath or inside the car. If they are inside the car they must be below the drivers seat and run from under the pedals, see pic)
11. A metal up-right made from a maximum of 38x38mm or a minimum 19x19mm by 2 to 3mm thick SHS must be welded or bolted to the centre of the front windscreen aperture. Wire mesh is permitted in front of the driver in this area.
12. Additional ironwork is permitted inside the car but it must not go "straight through" there must be a break of 150mm or 6" front to rear by either stepping, diverting or angling the iron work, At no point can this iron work be more than 2 pieces of steel doubled up side by side.

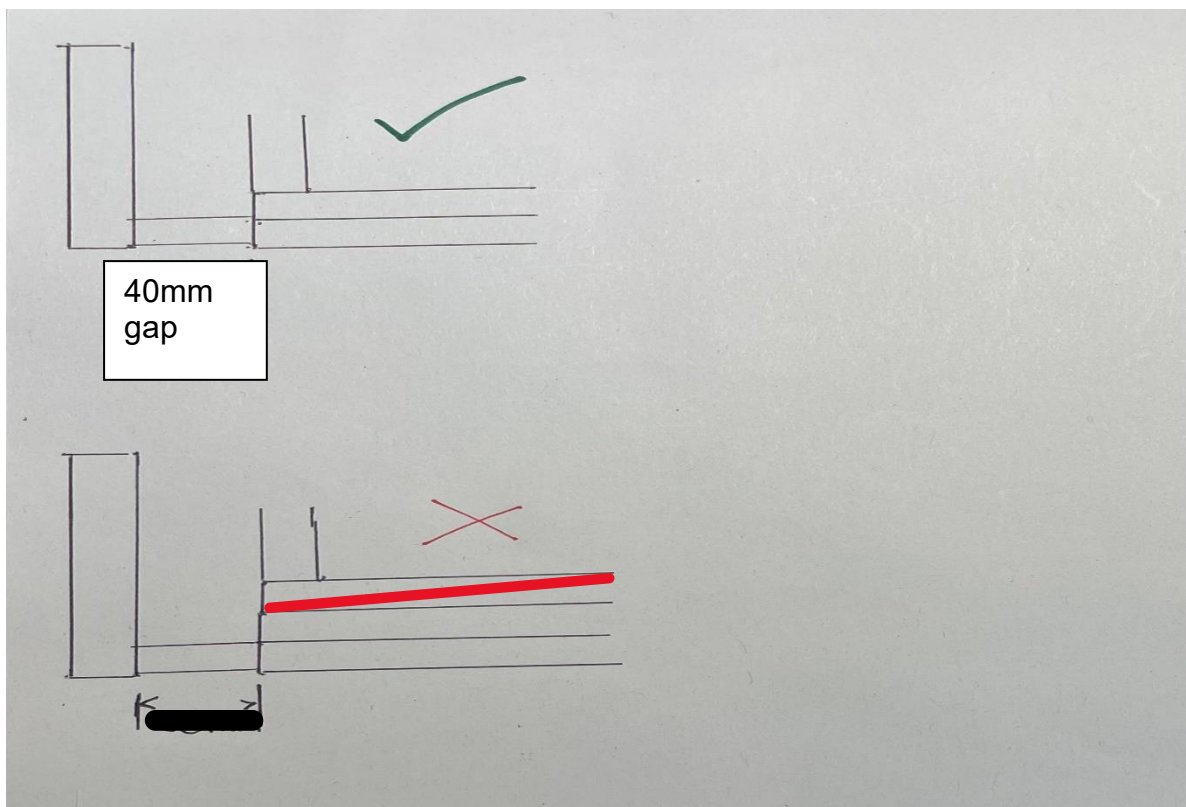

13. It is also permitted but not compulsory, to fit a brace off the upper passenger door chicken bar to the dash cross bar. This single bar made of 38mmx38mm or 40mmx40mm by 3mm thick SHS must go no further back than the centre of the front passenger door window aperture.
14. A single bar of 38mmx38mm or 40mmx40mm by 3mm thick SHS may be fitted from the nearside front lower bumper iron to the rear roll cage hoop cross bar. This bar & any connecting iron work must not be above the lower door chicken bar inside the confines of the roll cage.
15. Corner gussets of 150mm triangles are permitted but there must be no overlapping of the gussets.
16. Any part of the cage coming in to contact with the driver must be padded. If you have a leaning cross in the rear of the roll cage you only need one offside rear roll cage support . If no leaning cross you will need two rear roll cage supports.
17. Additional bracing at the base of the **A&B** hoops are required. These must be made of a minimum 32mm CHS/SHS x 3mm thickness (pics below)
 18. It is required that additional iron work is added to the top of the drivers door panel between the **A&B** hoops and braced down to the top inside side rail to add driver protection, These must be made of a minimum 32mm CHS/SHS x 3mm thickness
 19. The rear down bars may be braced down to the lower iron work to enable further support

Through the course of the 2026 season we will be reviewing roll cage and iron work specification and design for the future.



7. UNDER IRONS (Optional)

1. All iron work must be between 2.5 to 3.5 mm in thickness unless otherwise stated.
2. The under irons must be made of either 38x38mm, 40x40 mm SHS or 50x25mm RHS iron and may be cross-braced. They may also be connected to the internal iron work.
3. The under irons may pass under or over the axle, cross member or subframe.
4. Subframes may be mounted to the under irons.
5. It is compulsory to weld a 3mm thick driver's floor plate from just below the pedals to the rear of the driving seat if no under-irons are fitted. (under irons may run underneath or inside the car. If they are inside the car they must be below the drivers seat and run from under the pedals, see pic)



8. FRONT & REAR BUMPERS

1. The bumpers must be constructed of 38x38mm, 40x40mm SHS or 50x25mm RHS iron with a maximum thickness of 5mm & consist of a *maximum of 8* spaced uprights between the horizontal cross-bars. **The thickness of this material will be reviewed during the 2026 season with a view of maximum thickness of 3 or 4 mm for 2026.**
2. The bumper horizontal cross bars must be spaced a minimum of 305mm (measurement taken from the outside of the horizontal bars) apart top to bottom.
3. The bumpers may have straight or angled ends.
4. There should be a maximum of three pieces of iron joining each bumper corner.

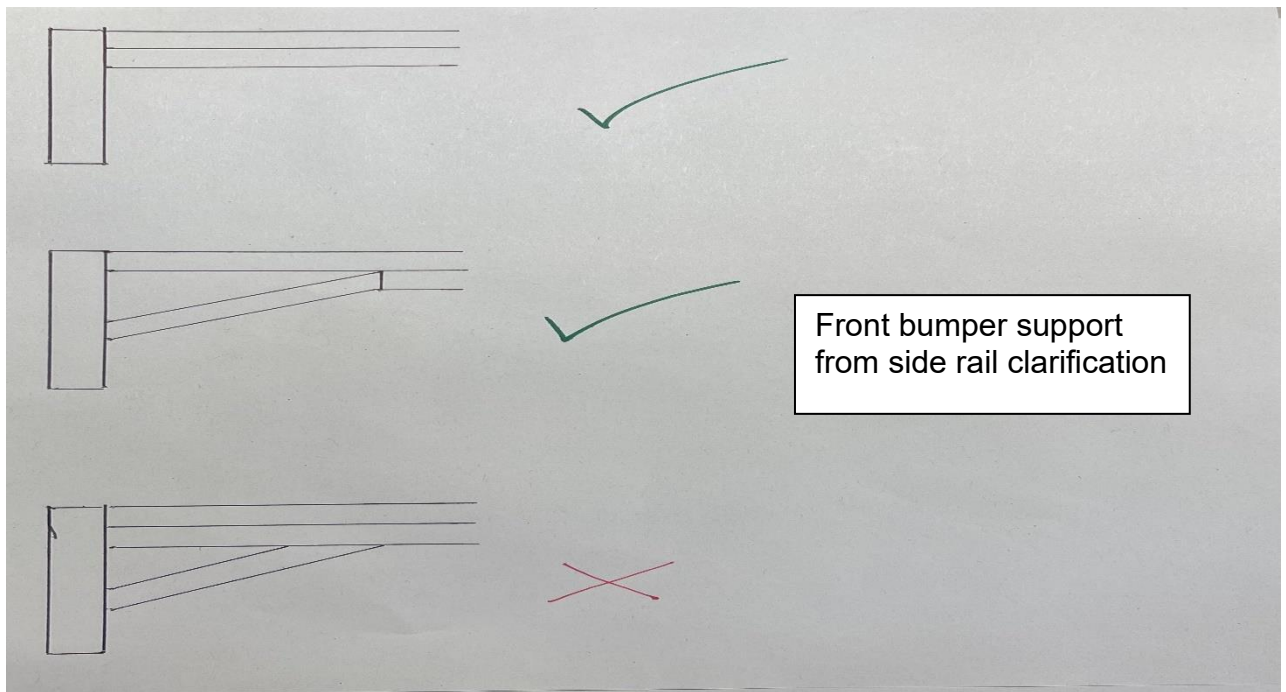

5. A rubbing iron made from 50x25x3mm or 40x40mm RHS iron may be welded to the fence side front bumper upright only. Please ensure that the welding of this rubbing iron has full penetration & the 50mm side of the iron is against the side of the upright.
6. The flat horizontal bars in the front bumper should have a minimum width of 750mm/29.5".
7. Bumpers must not have added steel as strengthening behind the bumper. A gap of approximately 40mm/1½" between the bumper and any other strengthening must exist. If the car does not have a rear panel to the floor, the rear bumper must be panelled in with plate of a maximum thickness of 1.2mm.
8. The only holes you may have at the rear are where lights were originally fitted .

9. SIDE IRONS

1. All side irons must be constructed from 50x25 x 3 or 4mm (or 40x40mmx 3 or 4mm) thick RHS iron.
2. When the outer panels are removed, the 3mm plate should be positioned behind the irons to infill the area between the side irons from the front to the rear wheels, substituting the outer panels.
3. **The minimum height from the ground to the top edge of the upper side rail is 620mm along the full length of the car**
4. **Both upper and lower side rails must have an inner side rail running behind the outer rail with no gap between them (butted together, see pic)**

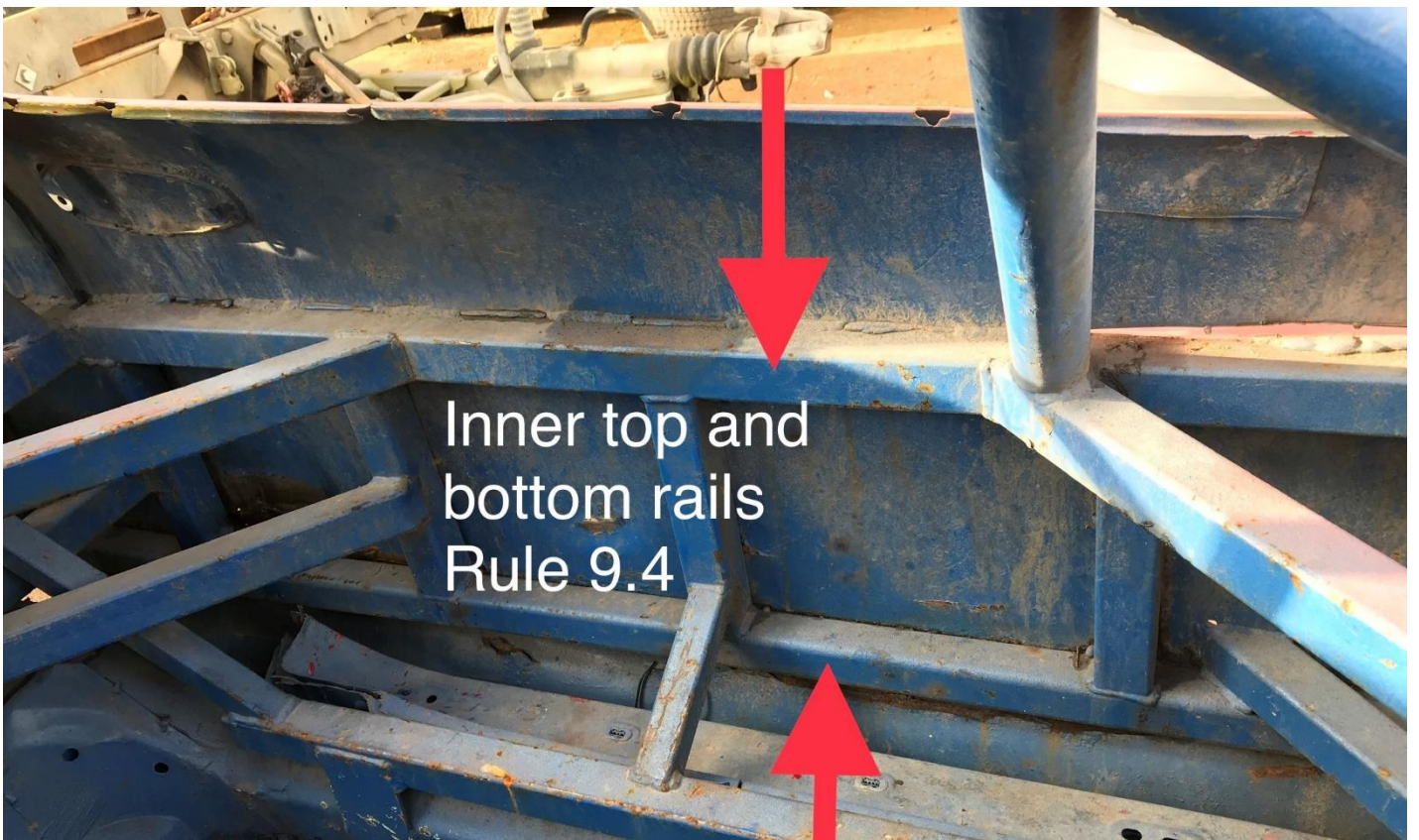

5. The bottom edge of the lower side rail must be above the top of the cars door sill



10. FRONT WHEEL PROTECTION

1. A single piece of iron either 38x38mm, 40x40mm or 50x25mm 3 to 4mm thick may be fitted centrally over both the front wheels, on the exterior iron work only, to protect the struts. The maximum length of this iron is 610mm & it must have rounded edges.

11. REAR WHEEL PROTECTION

The top part of the wheel rim must be covered to prevent the wheel breaking loose whilst racing and this may be done by one of two ways:

1. The lower side irons around the area of the rear wheel can have a frame made of 38x38mm or 40x40mm by 3mm thick SHS iron welded to them to stand off of the side irons. The front of this frame should be angled so that it glances off other cars but the rear part of the frame may continue on to join the rear bumper. This must be either a continuous curve or two bends and flat in the middle, they cannot have a single cut to create a point to cover the wheel
2. A section of heavy duty leaf spring with a suitable angled mounting bracket (50mm maximum protrusion) is located so that the leaf is secured at the front of the rear wheel, with a slipper bracket fitted to the rear of the wheel. The leaf spring bolt should be no larger in diameter than 12mm & the leaf must be cold worked, no heating of the leaf is allowed.

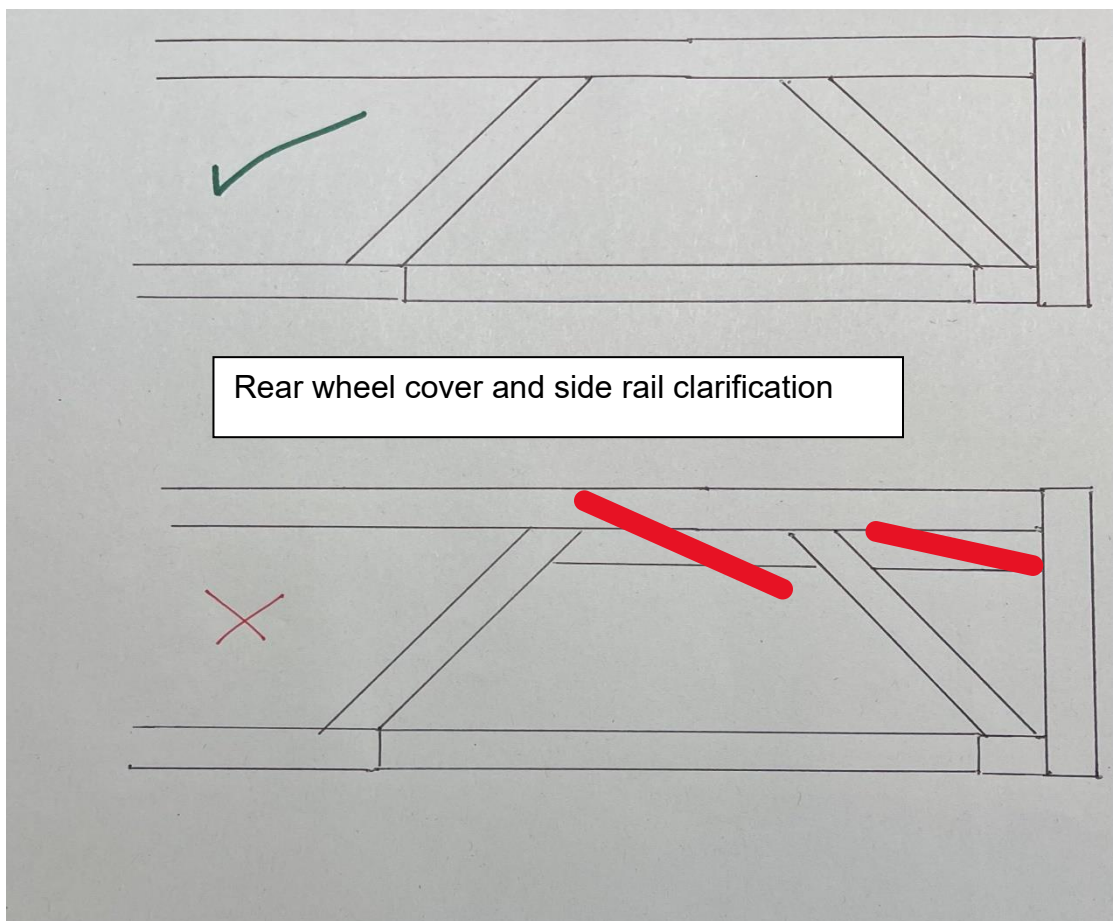

12. WHEELBASE

1. The wheelbase on both side of the car must be standard + or -- 25.4mm or 1" (This means rather ½" or 12.7mm on both wheels or one wheel standard wheel base and the other one to a maximum of 1" or 25.4mm forward or backwards). When the wheel base is checked the driver will be asked to set their wheels where they want them & once one side is measured they are not allowed to move the wheels to measure the other side. Drivers side wheelbase can only be adjusted if it is possible without modifying the standard parts (I.E by cutting or bending)
2. When repairs have been made to the suspension using standard parts & the wheelbase is found to be incorrect, washers may be added or removed from the front tie-bars or anti-roll bars only to bring it within specifications or this may be achieved any other way ie For the Honda cut the bottom arm.

13. VEHICLE WEIGHT

1. Cars may be checked (excluding the driver) at any time for there weight and they must weigh no less than 950kg and no more than 1050kg
2. Infringement of this rule carries a statutory ban from racing e.g. 1kg under or over is 1 month ban, 3kg is 3 months ban, and in excess of 3kg is a 6 month ban.
3. There is also a maximum of 53% inside (drivers side) weight

14. FRONT SUSPENSION

1. To be fitted as original no interchanging of parts within the manufacturers range to change the suspension geometry. Whatever is fitted on the nearside must be fitted on the offside.
2. Camber on N/S/F wheel must not exceed 15 degrees however achieved but must not be adjustable.
3. The N/S/F top suspension mounting may be repositioned to achieve negative Camber & Castor & be strengthened and must be welded fully in place, and not just tack welded. The geometry settings must not be adjustable.
4. The O/S/F suspension top mounting may be strengthened only and the wheel has to have 0 degree's – 2 degree's negative camber. **No Modifications & must remain on the standard bolt size.**
5. N/S/F front turret and chassis may be removed, O/S/F turret and chassis must be complete up to the front of the turret.
6. Anti Roll Bar may be removed.

7. Corsa C front hubs and shock absorbers may be fitted to a Corsa D or Vauxhall Adam but must be fitted both sides of the car.
8. You may weld a small piece of tube or tags to the original parts to keep springs in place. This may only be so the spring sits around the outside of them to stop the spring sliding from side to side.

15. REAR SUSPENSION

1. Must remain as standard & to manufacturers settings. Distorted axle beams must be reset with hydraulic equipment.
2. Race cars that have suffered damage or corrosion may strengthen or attach any suspension pick up point to the iron work, this can only be a maximum of one pick up point, if a car did get damage again it must have in writing from there promoter to get permission to move the second pickup point. But the pickup points must be in its original position.
3. Toyota Starlet link arms may be substituted for bars and bushes of a different size but the centres must be as the manufacturer's original dimensions.
4. Rear axle or swinging arms may have a support brace to strengthen.
5. During a meeting the rear wheels may be reset straight with the use of washers on the rear axle/hubs. To do this you MUST request permission from an official/scrutineer. They will then write in your licence that it was allowed at that meeting as a repair and then spray the axle to mark it. This axle will be required to be replaced for a straight one for the next meeting or repaired so no washers/packers are required for it to be straight. It is the drivers responsibility to get the scrutineers permission and to get this put in there book, there should be no washers in before the meeting starts. It is also the drivers responsibility to get this checked off at the next meeting when scrutineered to show the damage has been repaired
6. Rear suspension components / axles may use poly bushes.
7. You may weld a piece of tube or tags to stop the spring sliding from side to side.

16. THE STEERING

1. No quick racks can be used.
2. A quick release steering wheel is permitted.
3. Steering column height may be adjusted to suit the driver & the upper bracket strengthened.
4. Power steering may be used, this can be an adapted unit from any manufactured car.

17. THE SPRINGS

1. Springs are free (57mm or 2¼" are now permitted).
2. Only one spring is allowed per corner.
3. Packers / spacers may be used but must be fixed securely in place, they must be fitted to the top or bottom of the spring and not in between coils. These must be securely fixed in place as item 4 below.
4. If springs are not secured as part of the shock absorber (IE Vauxhall rear springs), they must be secured with a secondary fixing. This can be wire bond, seat belt or cable tie (Min thickness 1/2 ")

18. RIDE HEIGHT

1. This is measured without the driver, from the bottom of the sill (not the rebate lip) to the ground, Honda civic is measured to the underside of the rebate lip not the floor pan and this ride height measurement must be no lower than 178mm or 7". The test block must travel freely along the length of the sill between the front & rear wheels.

19. FRONT SHOCK ABSORBERS

1. The front Shock absorbers must be standard and available to everyone, through recognised outlets at a maximum cost of £150 plus VAT.
2. Gas & Gaz shock absorbers are allowed.
3. The shock absorbers must have NO exterior means of adjustment.
4. The casing must be original to the car or a replica of the original.
5. Spring platforms cannot be adjustable & must be in their original position **unless using new style GAZ shocks only with spring height adjuster as standard.**
6. Fixing bolts must be original in size, so as not to allow for any movement or angle change.
7. Fixing bolt holes maybe moved on passenger side to achieve negative camber but not slotted to be adjustable
8. Shock absorbers must be as from manufacturer, ie: Gaz shocker must remain with Gaz components including oil, No interchanging of parts or oil.
9. We will be looking at experimenting with different shock absorbers through the year to make this cheaper.
10. Shock absorbers may be re-valved but only by the original manufacturer. **GAZ only shockers.**

11. **New GAZ platform adjustable shocks may be used from 2026. Only Gaz versions are allowed supplied by Spedeworth Fabrications.**



20. REAR SHOCK ABSORBERS

1. Any standard production shock absorber, from any manufacturer that fits to the original mounting position without modification. The shock absorber maybe mounted of the iron work but be in the original position
- 2.No Gaz or competition types are allowed

21. WHEELS & TYRES

Any 13" wheel can be used up 5½" J in width

Tyres must be of the following:

1. **The only tyre to be used will be a Pace PC50 175/70/13**
 - Tyre buffing is permitted.
 - Tyre softener is not permitted
 - Tyre gaiters are permitted

22. FINAL DRIVE

1. You must use the standard axle for the car if it is a rear wheel drive car and you may change the final drive ratios but these must come from the same manufacturers range without machining or modifications to the standard part.
2. Front wheel drive cars are allowed to change the final drive ratio from the same manufacturers range without machining or modifications to the standard part.
- 3.You must lock the differential by welding only.
- 4.No limited slip differentials are allowed.

23. GEARBOX & PROPELLER SHAFT

1. The gearbox must remain as standard with all the gears, but ratios from the same manufacturer can be interchanged, but it must be without machining or modification of the standard parts.
- 2.The gearbox mounts may be solid with the exception of the rear gearbox mount but they may not be repositioned.
3. Rear Wheel Drive cars can interchange propeller shafts from within the manufacturers range.
4. Front Wheel Drive cars can use any drive-shaft from within the manufacturers range.
5. The original rear gearbox mount must be used and fitted in its original position and mounting point. This mount may NOT be strengthened. The only exception is when using The HRV Gearbox
6. FWD cars may lengthen the front nearside drive shaft.
7. You may convert a Vauxhall gearbox to cable gear selector using standard parts from the manufacturers range.
8. All cars may use a cable selected gearbox from the manufacturers range using standard parts.
9. You may convert a cable clutch system to hydraulic and vice versa using standard parts from the manufacturers range.

24. BRAKES

1. To remain as standard as fitted by the manufacturer without modification.
2. Front Wheel Drive cars however, may bypass brake compensators.
3. If brake compensators are being used, they must be installed to original pipe work layout, they cannot be altered.
4. Brakes must operate on all four wheels.
5. If the car being used only accepts 14 inch wheels you may convert the brakes to accept 13 inch wheels using brakes from the manufacturers range. **This may be done by machining the brake disk. You may add spacers to offset the calliper if required.**
6. Cars that come with plastic pedals may remove these and replace them with metal ones. If the brake pedal and master cylinder/servo is plastic or mounted on a plastic bulk head plate as standard this may be replaced with a metal version from the manufacturers range.
7. **Vauxhall Corsa D and Adam may use a Corsa C calliper and part No FEB22876 brake disk (230mm VW Lupo).**

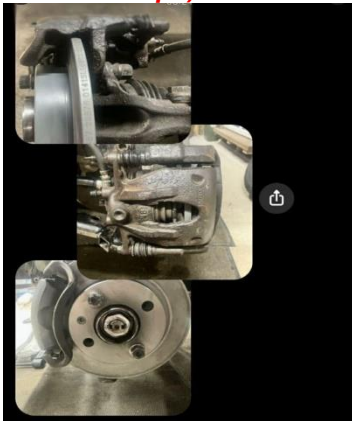

25. ENGINE

1. The Engine must be standard to the car, the exception being the Vauxhall Corsa/Tigra, which must use the Nova specification engine.
2. **All engine components must remain standard** and not be interchanged between models with different engine sizes.
3. Toyota 3K & 4K engines must NOT use the cylinder head with the ports larger than 29mm.
4. The bores may be machined out to a maximum of 1.5mm oversize.
5. Cylinder head & piston combinations must be as manufactured.
6. The cylinder block may have its head gasket face skimmed only.
7. The maximum piston protrusion is 0.010".
8. Piston crowns must have their identification markings visible.
9. The cylinder head may be skimmed on its head gasket face only.
10. Head bolts may be shortened or washers used as spacers.
11. The head gasket cannot be modified in any way.
12. If the oil feed to the head becomes misaligned when the head is skimmed it may be re-aligned.
13. No welding may be done to the head either as repairs or modifications.
14. Valves must be standard
15. Three-angle valve seats are permitted. The measurements of the three angle valve seats are as follows; Angle 1; Combustion chamber 30° - Angle 2; Valve seat 45° - Angle 3; Port 60—65° with valve seat width free.
16. The original manufacturers' part, or any other manufacturers' standard or pattern replacement springs may be used (no competition types).
17. Rocker arms must be standard or pattern replacement. Vauxhall OHC engines are permitted to use the Diesel rocker as a replacement
18. The standard sump may be baffled
19. The oil pick-up pipe may be modified within the confines of the sump.
20. The engine position cannot be altered but the engine may be tilted to stop fuel starvation, engine mountings may be solid and can be picked up from the iron work
21. The engine may be restrained.
22. You must use a standard flywheel and clutch to the engine the face maybe skimmed 1300 Vauxhall flywheel weight minimum 5kg and Toyota starlet flywheel 4k RWD May be lightened but no holes
23. Vauxhall 1300CC Engines - any crank may be used from the same manufacturer providing it has the same stroke as the standard Vauxhall 1300cc crank – any oil pump may be used to suit.
24. The Toyota Starlet 4K RWD May use a competition Cam and the Weber 32/34 DMTL carburettor
25. The key way or crank shaft pully may be modified if you are running a standard ecu only .

26. ENGINE SEALING

The Promotion may at any time require your engine or other parts to be sealed. This may or may not mean your engine / parts will automatically be stripped or checked. It could be that we wish to monitor your performance or seek clarification on an item. It is normal to strip engines at all major championships unless they run consecutively in which case by agreement with The promotion, stripping may be postponed.

Driver: Drivers wishing to have their engines sealed may do so. It will require two people (one may be an official, the other a Scrutineer) to be present at the final stages of a build & it will incur a charge based on the time & distance travelled. If this option is taken at a major championship your engine will not require stripping, unless the seals have been broken. Seals can only be removed by The promotion's officials & if they are removed without permission the engine / parts will be deemed to be illegal & the Driver suspended pending a Board of Control meeting. If any engine/ parts are sealed because Championship events are within a period, which may exclude that Driver due to a rebuild, the Driver with The promotion's agreement, postpone stripping for three meetings.

It is the Driver's responsibility to make provision for the sealing of the engine by drilling 1.5mm sealing holes in the following bolts / nuts & marked with red paint for identification purposes:

- Either side of the Sump
- Two Head bolts, if not covered wholly by a rocker / cam cover.
- Two Inlet manifold bolts
- Two Rocker / Cam cover bolts
- The Bell housing
- The Carburettor body and the mounting bolts / nuts

27. OIL CATCH TANK

1. An oil catch tank (no drink cans or bottles – minimum capacity of 0.5 litres) must be fitted in the engine bay.
2. The tank must have a minimum of 2 breather pipes connected to it: one from the rocker box and one from the crankcase. Breather pipes are free but must go to a catch tank.
3. Ineffective tanks during racing or practice will mean the car being withdrawn from the event.

28. COOLING SYSTEM

1. Radiators are free, but they must occupy their original position.

29. IGNITION SYSTEM - DISTRIBUTOR

1. Distributors must be the Standard manufacturer's part.
2. No electronic ignition unless it's fitted as standard.
3. The Vacuum must be fitted but may or may not work, the base plate may be locked
4. The Vauxhall OHC engine may use the Bosch distributor with contacts or the AC-Delco type with electronic ignition.
5. This does not include the evolution engine distributors which must stay standard in every way, Vacuum pipes may be blanked off
6. **Evolution ECUs may only use 2d ignition mode. 3d ignition mode must not be used.**

30. CARBURETTOR & INLET MANIFOLD

1. The Carburettor & venturi size, must be as listed in the table of eligible cars on page 2.
2. The Idle, Air Correction & Main Jets may be drilled to adjust the mixture strength only.
3. The Cold starting Choke Butterflies may be removed.
4. The Carburettor body must not be modified in any way and any economy devices must be fitted.
5. A secondary fixing is required on the Carburettor fuel inlet pipe if it is of the hose type.
6. Water circulation holes in the inlet manifold may be blanked off.
7. Exhaust manifolds with a Hot Spot under the Carburettor may blank it off.
8. Air filters may be removed.
9. No Ram pipes, Bell mouths or Stubs are allowed.
10. For Novas, Corsas and Tigras using the Pierburg 2E3 Carburettor. **Venturi's of 20 /24mm and a 8mm/7mm pre-atomiser diameter. Needle valve/fuel inlet must be no larger than 1.55mm as standard. This will be checked by using a 1.6mm drill bit which must not enter the hole.**
11. Vacuum pipes may be blanked off .
12. The vacuum pipe from the manifold to the servo must have the one way valve fitted the correct way and must be working.
13. **Two carburettor gaskets Part No: 9990051300 may be used to seal restrictor plates and carburettors but these must be one either side of the restrictor plate**

31. FUEL SYSTEM

1. Fuel tanks must be metal/*alloy* or FIA approved & fitted inside the boot or rear area, but not below the rear chassis rails.
2. A complete fire wall must cover the tank and electric fuel pump.
3. The tank must have a maximum capacity of 18 litres.
4. Fuel caps must be of a metal screw type, no push fit types are allowed
5. The tank must have a positive means of fixing.
6. The fuel outlet must be from the top of the tank.
7. Fuel regulators are allowed.
8. An electric fuel pump can replace the mechanically one.
9. All fuel lines must be inside the car and be metal or metal covered ***or specific rubber braided fuel hose, rubber / plastic connecting hoses are not permitted.***
10. A fuel shut off tap must be within easy reach of the driver.
11. A breather pipe must be fitted which should incorporate a one – way valve, with the pipe terminating below the tank so as to prevent spillage if inverted.
12. Where a floor exists a hole the size of the tank must be cut underneath for drainage purposes.
13. Only roadside fuel can be used. No additives are allowed.
14. If the tank is contained in a box it must not have a floor in it.
15. The rear face of the fuel tank can be mounted no further forward than the centre line of the rear wheels and must have minimum gap to the rear bumper of 300mm. It should be mounted centrally in the car between the rear chassis rails.

ALL OVAL RACING FORMULAE

Permitted fuel specification from 1st January 2008 (this specification supersedes all previous specs).

1. All cars must only use fuel from roadside pumps as defined below.
Petrol (Motor Gasoline of the type on sale to the general public from roadside filling stations) BS 4040 (Leaded) Subject to a valid permit for use. LRG (Unleaded), BS EN 228 (Unleaded), BS7800 (Super Unleaded).
2. Petrol is a product refined from crude oil that contains a large number of identifiable compounds that can typically be 250 in number. These compounds can be identified and compared to the available petrol from major oil companies and suppliers.
3. Unless otherwise stated, or the distinction is made between leaded and unleaded petrol, major gasoline fuel shall meet the following; Acceptance levels for Octane numbers will be determined at 95% confidence level. Only additives to this motor gasoline fuel solely for the purpose of lead replacement are allowed.
4. Lead Replacement Gasoline, LRG, also known as LRP. Only additives from Sodium, Phosphorous, Potassium, or Manganese according to manufacturers recommendations are allowed. Note; Manganese can enhance octane values in any petrol. Under no circumstances will values in excess of 0.005 grams/litre be permitted.
Lead in excess of EU directive 98/70EC requirements is illegal.
5. We reserve the right to amend the detail of the above specification to reflect any change occurring in the quality of the fuel on sale to the general public at any time.

Roadside fuel consistency when testing fuel samples.

	BS EN 228	BS 7800	BS 4040	LRG/LRP	Test Standard
Motor Oct No (max)	89.0	89.0	89.0	89.0	ASTM D2700/86
Mon (min)	85.0	86.0	86.0	86.0	ASTM D2700/86
Research Oct No (max)	100.0	100.0	100.0	100.0	ASTM D2699/86
Ron (min)	95.0	97.0	97.0	97.0	ASTM D2699/86
Lead (max)	0.005	0.005	0.15		ASTM D3341 / IP362
Lead (min)	ASTM D3237	ASTM D3237		0.005	ASTM D3237 / D3341 / IP362
Density @ 15°	0.720 - 0.775	0.720 - 0.775	0.720 - 0.775	0.720 - 0.775	ASTM D1298/ D4052
Oxygen % max	2.7% w/w	2.7% w/w	2.7% w/w	2.7% w/w	Elemental
Nitrogen % max	0.1% w/w	0.1% w/w	0.1% w/w	0.1% w/w	ASTM D4629/ IP379
Benzene % max	1.0% v/v	1.0% v/v	1.0% v/v	1.0% v/v	EN238
Sulphur	150mg/kg	150mg/kg	150mg/kg	150mg/kg	EN ISO 14596 / ASTM D2622
Olefins*	18% v/v	18% v/v	18% v/v	18% v/v	ASTM D1319
Aromatics*	42% v/v	42% v/v	42% v/v	42% v/v	ASTM D1319

* Olefins and Aromatics values are expressed as a percentage of total fuel.

32. EXHAUST SYSTEM

1. Any standard cast exhaust manifold from manufacturers range maybe used without any form of modification to fit
2. If the engine being used had a tubular exhaust manifold as standard this may be used but NO aftermarket tubular manifolds maybe used
3. Lambda sensors maybe blanked or capped off
4. Any standard downpipe from the manufacturers range that fits the exhaust manifold flange without modification maybe used
5. The downpipe section maybe re-shaped to miss obstructions by way of heating, bending or cutting the standard downpipe but the standard bore of pipe must not be altered. ~~The first 100mm of downpipe from the manifold flange must remain standard~~
6. Where the downpipe collects from 2-1 you may remove the bolt flange fixing connecting the downpipe to the tail pipe. You may weld the remaining exhaust pipe and silencer from this point.
7. The length of the downpipe must remain standard from manifold flange to the collector.
8. No stainless systems can be used

9. You may remove the bolt flange at the end of a standard single downpipe and weld the remaining exhaust pipe and silencer from this point.
10. You must use either the Ford E1ADDN5320A (an equivalent cross reference one is allowed) or the AX891 silencer. *Alternatively, the system standard to the car may be used or a BriSCA F2 type.*
11. There must be 254mm or 10" of tail pipe maximum & 50.8mm or 2" minimum on the end of the silencer facing rearwards.
12. Any part of the system passing through the inside of the car must have heat shielding around it.
13. If your exhaust becomes ineffective in the last 5 laps of a race you must pull off, as you will be automatically removed from any results.
14. The exhaust system must finish no further back than the B pillar line of the car (This is due to the rear floor now being open and not wanting fuel to spill onto a hot exhaust system) in the case of the Vauxhall tigre and Honda CRX the exhaust must finish no further back than the rear of the front floor pan
15. **No ceramic coating or any other coating is allowed except heat wrap.**

33. BATTERIES & THE ELECTRICAL SYSTEM

1. The Batteries must be securely fixed & covered with rot proof material if they are not of the sealed type.
2. No battery box only adequate clamping.
3. Battery position is free & a maximum of two batteries is allowed. Oversized batteries used for ballast are not permitted.
4. The Battery must be 152mm or 6" away from the fuel tank.
5. Contact between the safety harness & the Battery should not be possible
6. A battery master switch must be fitted in the rear left-hand window and clearly marked "ON- OFF" or have an electrical danger decal.
7. When an electric fuel pump is used, a cut off switch must be positioned within easy reach of the driver.
8. A self-starter motor must be fitted & working at all times.
9. All Battery isolator switches must cut all power supplies in the car when switched off
10. The original alternator may be used but may be mounted differently than standard and use a different size belt
11. Battery trays/holders must be made from steel minimum 3mm thick. They must be bolted or welded in position using minimum M10 thread / bolts. The clamp to secure the battery should also be fixed using minimum M10 stud / bolts.

34. TRANSPONDER

1. A Transponder is mandatory & it must be fitted 1.8m back from the front position of the car. ~~*Trackstar & Startrax drivers are not required to have transponders and transponders will not be used at King's Lynn or Startrax circuits.*~~ **All drivers regardless of licencing promoter must now be fitted with a functioning transponder.**
2. A hole 150mm or 6" in diameter or square, must be cut in the floor & the transponder fitted above it.
3. In the event of a dispute with a transponder result, then the Steward of the meeting will make the final decision.

35. MIRRORS

1. A mirror is allowed.
2. Maximum size of the mirror is 152x100mm or 6x4" & it should be covered with a clear plastic film to prevent it shattering.
3. **Only one mirror is allowed and this has to be the rear view mirror.**

36. BODYWORK

1. **Body shells & panels must remain as manufactured & must retain the original silhouette.**
2. Front wings below the ironwork may be removed.
3. You may weld the front wings to the bonnet
4. Original foot wells must stay in the original position.
5. Original bulkhead must stay in the original position. You may cut into the bulkhead for allowing ironwork to pass through.
6. Roof inner lining may be removed but if the roof is flexing it must have plates welded in place to hold in the original position.
7. Spare wheel well can be removed but MUST be replaced with flat plate up to the centre line of the rear axle (the centre line is determined by the centre of the stubs).
8. Plastic scuttle panels at the top of the bonnet must be replaced by a fabricated metal panel
9. All cars racing must have the front part of the rear wheel arch in place (see Pic), if removed they must be made of Metal. No plastic

10. All new cars built or unraced before Jan 2020 must have the original inner and outer front half of the rear wheel arches
11. Outer sills maybe replaced with Tin but part of the original sill with the drop-down lip must still be in place, the guts in between inner and outer sill may be removed
12. The 'A' pillar can only be cut and removed approximately 1 inch above the top wing iron down to level with the top of the sill (see Pic).
13. The upper roof 'A' pillar inner skin may be removed (see pic) along with the inner skin from the rest of the roof
14. The boot floor maybe removed from the rear of the car to the centre of the rear wheels, The boot floor must also be removed underneath the petrol tank. If suspension mounting parts or brackets are attached to this part of the floor then that area must remain in place as original but the floor pan may be removed around the mounting part or bracket , the reason for this is the need for the area beneath the fuel tank to be open and allow for fuel to drain away in the event of a split fuel cell.
The rear of the fuel tank can be mounted no further forward that the centre line of the rear wheels
15. 'B' Pillars may be removed from the lower window edge to the top of the sill, the inner skins may be removed above the lower window edge
16. The tops of the door skins must be in place unless they are simply a window frame
17. You may run a tape or mesh net shield in the driver's side windscreen aperture for inclement conditions, this must be removable and fixed with ties or tape only
18. You may run a shield in front of the radiator.

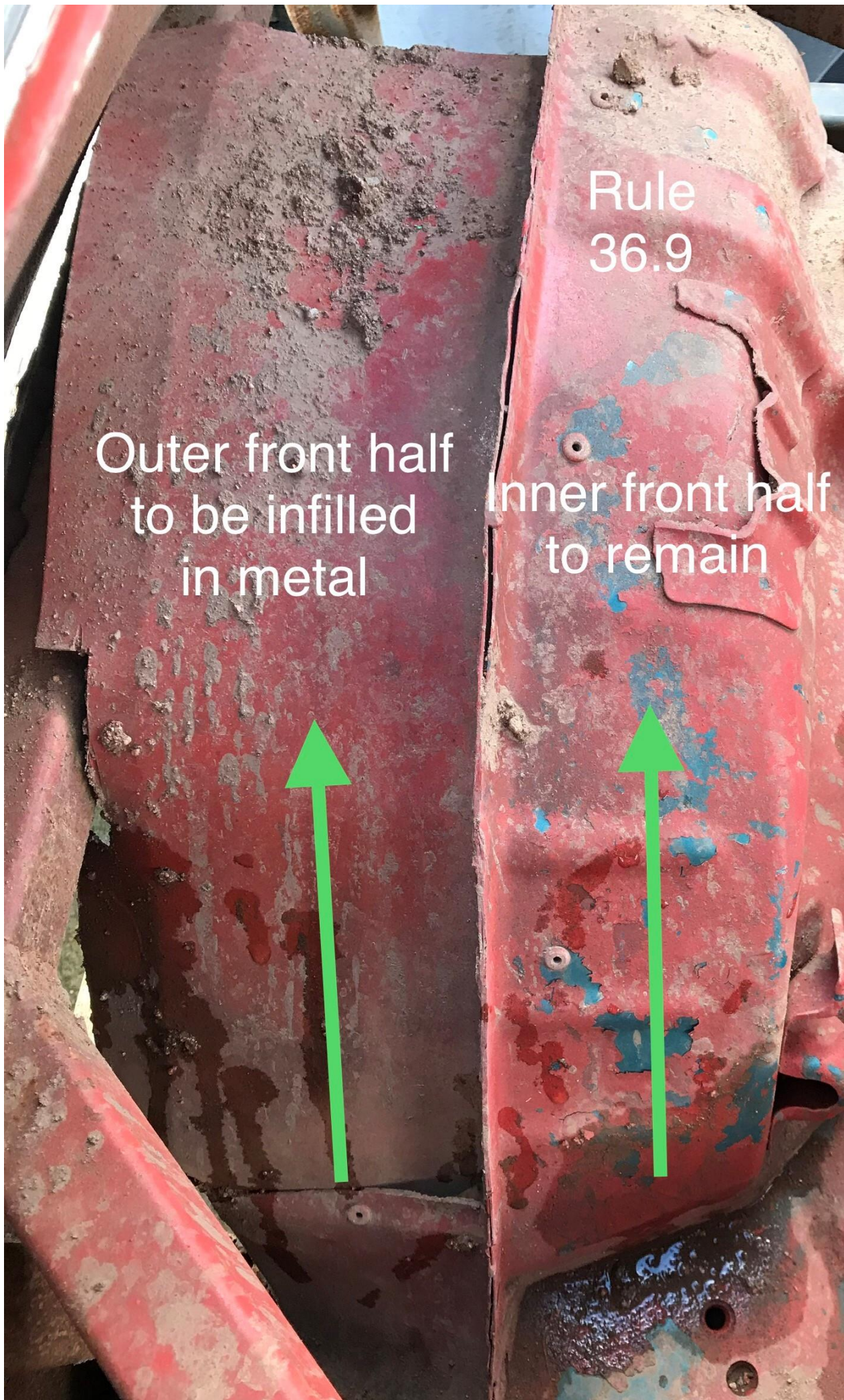

Rule
36.9

Outer front half
to be infilled
in metal

Inner front half
to remain





Rule
36.10

New cars not raced before
January 2020 must have original
inner and outer, front half of the
rear wheel arches in place

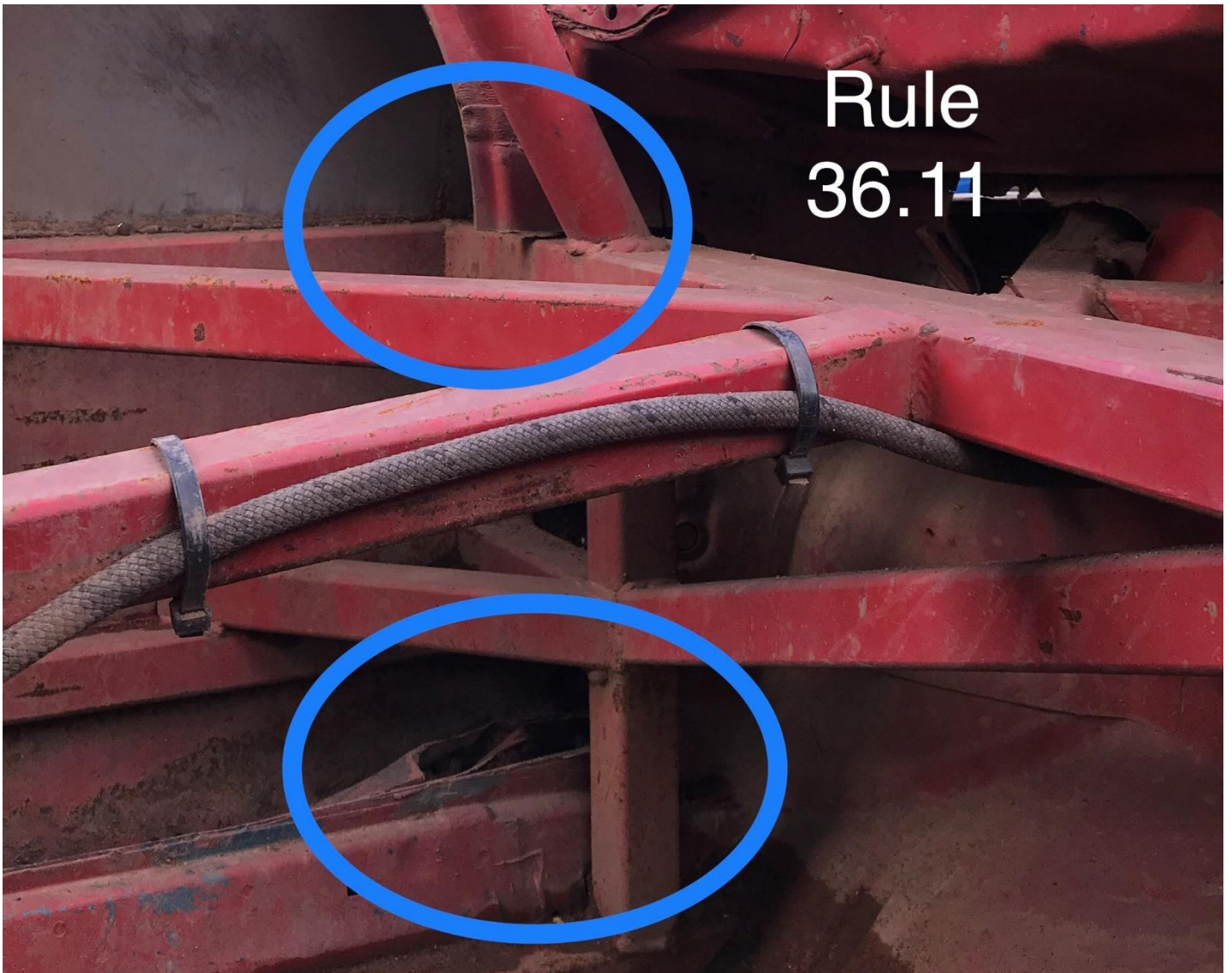

Rule
36.11



Rule 36.13

inner
skin of
the 'A'
roof
pillar

37. PAINTWORK

1. The external appearance of the car must look professional at all times, drivers of scruffy looking cars will be told to improve their appearance & may not be allowed to race.
2. A maximum of two cars may be painted in team colours or painted to look similar, unless it is required by the Promoter for a particular team event.
3. 100% of the roof must be painted in the correct roof grading unless you are a Superstar or a current Championship holder, when the roof must be painted accordingly.
4. Sign writing must be professional and be approved by the Promoter.

38. SUN VISOR

1. A Sun visor may be fitted with your name written upon it.

39. FIN PLATES

1. Fin plates must be fitted above the roof line but it should not be larger than 305mm or 12" by 559mm or 22" wide.
2. Fin plate numbers must be 229mm or 9" high by 38mm or 1½" in width, plain black numbers on a plain white background only. Please ensure they are correct. No Holographic numbers or backgrounds. The top of the fin must be minimum 5" high from the top of the fin to the roof it is fixed too.

40. DOOR NUMBERS

1. The drivers racing number must appear on both sides of the car. The numbers should be 300mm or 12" high x 50mm or 2" wide, on a contrasting background, which must extend a minimum of 50mm or 2" beyond the numbers.

41. ROOF GRADING

1. All roof grade champions must start at the rear of the Grid, unless told otherwise by an official.
2. If you win a race at a meeting; you will start the remaining races from the rear of your grade. Should you win another race at the same meeting – you will be automatically upgraded.
3. Champions should start in the order of the list below, but multi-Champions will start next to the World Champion.

Grid Line up / Roof Order:

- White (Novice)
- Yellow
- Blue
- Red
- Superstar (Red, White & Blue Stripes)
 - *Trackstar Superstars are denoted by flashing amber lights*
- Silver Roof – *Points Champion (Spedeworth, TSR & Startrax*
- Twin silver stripes – *Current National Points Leader*
- Twin Gold Stripes – World of Shale Champion*
- White with Red Cross – *English Champion*
- Blue with White Cross – *Scottish Champion*
- Union Flag – *Best In Britain*
- White/Red Chequered – *Inter-Nations Cup*
- Gold Stripe – *National Champion*
- Black & White Chequered – *British Champion*
- Red & Yellow Chequered – *European Champion*
- Gold – *World Champion*

42. SPECIFICATION AND RULE CHANGES

The Promotion may at any time make amendments to the Specifications for the following reasons:

- In the interests of Safety
- Reduce costs for the driver
- In areas that are detrimental to the future of the formula
- If an unnecessary advantage has been deemed.

Current registered drivers will be notified automatically of any changes.

43. SCRUTINEERING OF NEW CARS

All new cars must be scrutineered prior to their first meeting. Arrangements must be made with your promoter to bring the car along to a stadium on the day of an event and then your car will be scrutineered.

44. RACE REPAIRS AT TRACK

All repairs done at the track to continue racing for that meeting must be made correct to the rules for next meeting I.E straightening bent / broken components.

Any iron work repairs must be done using the correct size and shape material.

The maximum thickness plate steel that can be used is 3mm.

The maximum size angle steel or flat bar that can be used is 3mm x 40mm.

SPEDEWORTH / TRACKSTAR EVOLUTIONARY STOCK CAR SPECIFICATION

New Eligible Cars:

Manufacturer	Model	Engines	Carburettor
Citroen	AX	1360cc 8v	32/34 Weber DMTL
	Saxo C2		
Ford	Fiesta	1388cc 16v	32/34 Weber DMTL
	KA		
	Puma		
Honda	Civic	1343cc 16v or 1386cc 16v	32/34 Weber DMTL
	CRX Logo		
Nissan	Micra	1275cc 16v or 1392cc 16v	32/34 Weber DMTL
	Sunny		
Peugeot	106	1360cc 8v or 16v	32/34 Weber DMTL
	205		
	206		
Renault	Clio	1390cc 8v or 16v	32/34 Weber DMTL
Suzuki	Swift	1298cc 16v	32/34 Weber DMTL
Toyota	Starlet FWD	1332cc 16v	32/34 Weber DMTL
	Yaris	1299cc 16v	
Vauxhall	Corsa	1389cc 16v or 1389cc 8v	32/34 Weber DMTL
	Tigra		
	Nova Adam		
VW	Polo	1390cc 8v or 16v	32/34 Weber DMTL
	Lupo		

***Drivers wishing to race alternative vehicles must contact the Promoter.**

Car construction specs and all other rules are the same as the original rule book.

ENGINES

NEW ENGINES

When using any of the following type of engines, any driver with the same type of engine in their car, a car it could be fitted into or promoter can buy your engine at the end of a meeting There will be a buying price for these engines of **£1150+VAT** The engine must be complete but excluding clutch and flywheel, excluding carburettor and inlet manifold and distributor. An engine cannot be brought within 3 weeks of a major championship.

Restrictor plates will be used to govern competitive performance for all new type cars.

1250cc – 1350cc Multi-valve / 1351cc - 1400cc 8v or Multi-valve Engines

The engine must be standard. ~~No oversized boring of pistons allowed.~~ **+20 pistons may be used.** All engine components must remain standard ~~and must not be interchanged from different models with different engine sizes.~~

Restrictor plate dimensions for these engines are as follows:

Restrictor plates must be a maximum of 5mm thick flat plate even from side to side

A Straight through hole must be drilled or punched with no radius no grinding or fettling.

Diff ratio and gearbox ratio are free within the manufacturers range but the diff must be locked by welding.

Vauxhall 1400 multi valve engine (with Weber carb) will have to use a 20mm restrictor plate.

Vauxhall 1400 8v non se engine may use the 1400 manifold with the pierburg 2E3 carburettor (Again we state non SE). Without restrictor plate.

Restrictor plates may be changed at any time by the promoter or steward to keep all cars competitive.

Evolution ECUs may only use 2d ignition mode. 3d Ignition mode must not be used.

Carburettor

If the engine being used came originally with either single point or multi point fuel injection, the injection system must be removed and replaced with a WEBER 32/34 DMTL carburettor if you use the original inlet manifold. If a standard inlet manifold from another make or model fits the engine it may be used. If there is not one available, an inlet manifold may be fabricated or adapted to fit the engine and incorporate a WEBER 32/34 DMTL carburettor. A conversion plate no thicker than 1/2" may be used for either the inlet manifold, the carburettor or both.

The Carburettor must have the weber manufacturers mark .

- Air filters may be removed or replaced.
- No ram pipes, bell mouths or stubs are allowed.
- Choke butterflies and cold start equipment may be removed but economy devices must be fitted as standard.
- The slow run air correction main jet, where fitted, may be drilled to adjust mixture only.
- The carb' Venturi size must not be altered.
- The carburettor body must not be altered or modified (linkages may be made to take throttle cable).
- You may change the fuel filler jet/needle valve to an uprated weber unit. This is to improve the seal shutting off fuel into to fuel bowl.
- The exhaust manifolds with a hot spot under the carburettor may be blanked off.
- The standard sump must remain, but may be baffled and the oil pick up may be modified within the confines of the sump.
- Cylinder head may be skimmed. The head gasket must not be modified in any way.
- If the oil feed to the cylinder head becomes misaligned when the head is skimmed it may be realigned.
- No welding of cylinder head, either repairs or modifications.
- Valve springs must be the original manufacturers' part to the engine used.
- Engine mountings may be solid. The engine position must not be altered
- The engine may be tilted to stop fuel starvation.
- Any electronic ignition system can be used.
- Distributors must be standard manufacturer's & not modified in anyway, vacuum pipes may be blocked.

- The Vauxhall 16v engine must use all 7 standard that come as standard on the engine from Vauxhall (2x cam pulleys, 2 x idler pulleys, water pump, tensioner and crank pulley).
- Camshaft idle engine mount must bolt with the 3 bolts standard size.

The only base insulator block to be used is the weber type part No: 9990051300 no tapering / funnelling of any kind is permitted

Two carburettor gaskets Part No: 9990051300 may be used to seal restrictor plates and carburettors but these must be one either side of the restrictor plate

FLYWHEELS

Flywheels must be standard. The minimum weight must be 7.3kg

These rules may be revised at any time during the course of the season for the benefit of the formula and to ensure competitive racing.

Please note that all of the above rules are subject to change in respect of Health & Safety requirements.

REVISED RULES FOR 2026 HIGHLIGHTED IN BOLD/ITALIC/RED PRINT

ITEMS MARKED ~~STRIKETHROUGH~~ ARE NO LONGER ALLOWED

2026 1400cc Stock Car Technical Specifications, Issue 3, Dated 08/04/2026